



TRUCK STORAGE SOLUTIONS  
SECURING YOUR REPUTATION

# INSTALLATION MANUAL TRANSFER TANKS

ATTENTION: PLEASE READ AND UNDERSTAND ALL INSTRUCTIONS AND WARNINGS BEFORE ASSEMBLING, INSTALLING OR USING THIS PRODUCT.

**MODELS** 350-X-02, 352-X-02, 354-X-02, 358-X-02, 359-X-02, 360-X-02

**Note:** X represents the color code for your model: 3 = White | 5 = Black

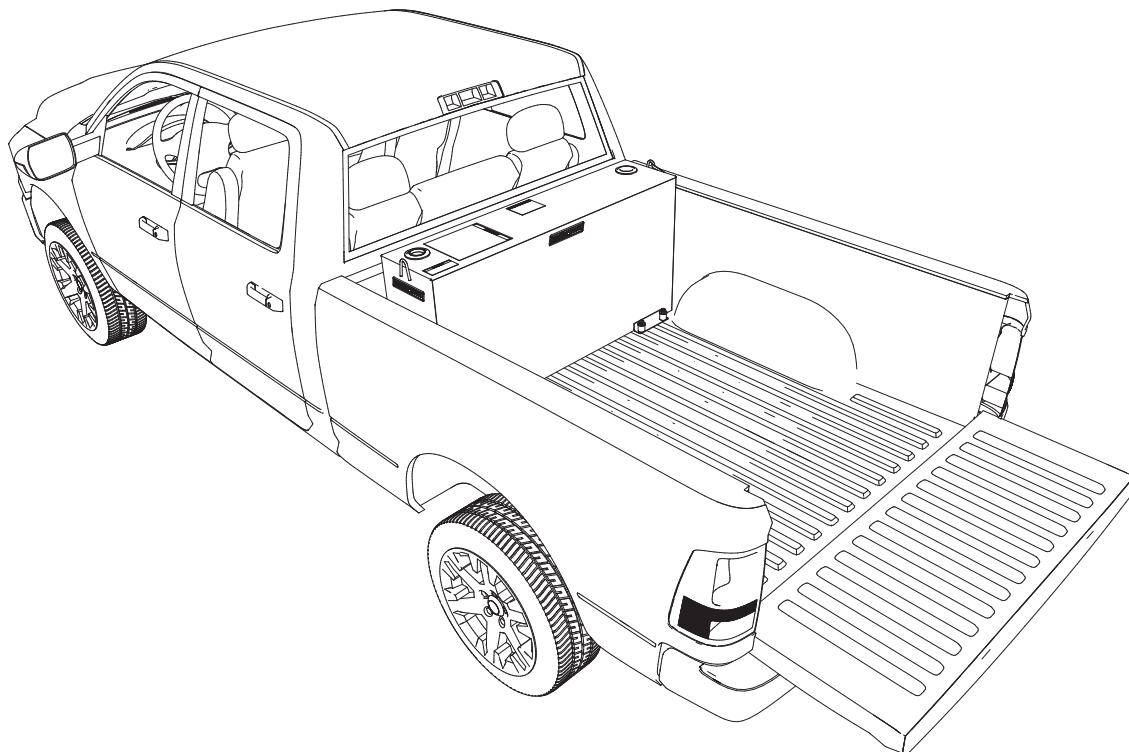

## ⚠ NOTICE

Use specific aluminum upfit components when installing WEATHER GUARD® products to aluminum truck beds. Follow additional instructions if mounting to an aluminum truck bed. There may be left over components depending on upfit.

Any modification or unintended use of this product shall immediately void all manufacturers warranties. Manufacturer disclaims all liability for injuries to persons or property resulting from any modification to, or unintended use of this product.

When warning decals cannot be read or when they do not stay affixed to the transfer tank, the owner of this product is legally responsible for replacing these warning decals for free by contacting: Werner Co. at 420 E. Terra Cotta Ave., Crystal Lake, IL 60014 or call 1-800-456-7865 for free replacements.

## ⚠ CAUTION

Transfer tank bottom must be fully supported by the floor of the truck bed so as not to cause flexing of the tank which could cause stress cracks and leakage of the tank. To keep debris out of your eyes when checking the underside of the vehicle, or when drilling, always wear protective eye wear.

## ⚠ DANGER

Danger of explosion. Do not use this product for storing or transporting flammables, explosives, hazardous materials, or hazardous waste, such as containers of gasoline, solvents, gun powder, dynamite, propane tanks, acetylene tanks and cutting torches. This product is only intended and safe for use in storing and transporting non-flammable liquids. Any modifications made to, or unintended use of this product, could create a hazardous condition that can cause death, serious personal injury or property damage.

## ⚠ WARNING

Prior to drilling, so as not to cut or puncture fuel tanks, fuel lines, electric wires, etc., check under vehicle for locations. All floor mounting bolts near the gas tank area should be installed from the underside of the vehicle, to guard against the gas tank being punctured in the event of a collision. This would mean not using Blind Fastener in this area. Holes drilled in this area should be 9/16".

## ⚠ DANGER

Use of flammables in this transfer tank may cause an explosion, resulting in serious bodily injury, death, or property damage.

To avoid such risk:

DO NOT use this transfer tank to transport, transfer or store flammables, such as gasoline.

DO NOT use this transfer tank as an auxiliary fuel tank by connecting it to an existing fuel system.

DO NOT use this transfer tank for fueling aircraft.

DO NOT modify this transfer tank in any way or use it for any purpose other than its intended use.

DO use this transfer tank only for the transport, transfer or storage of diesel fuel only.

DO use this transfer tank only in fueling land-based motor vehicles and equipment.

DO vent this transfer tank at all times to allow for fuel expansion and to prevent vacuum during fluid or fuel removal.

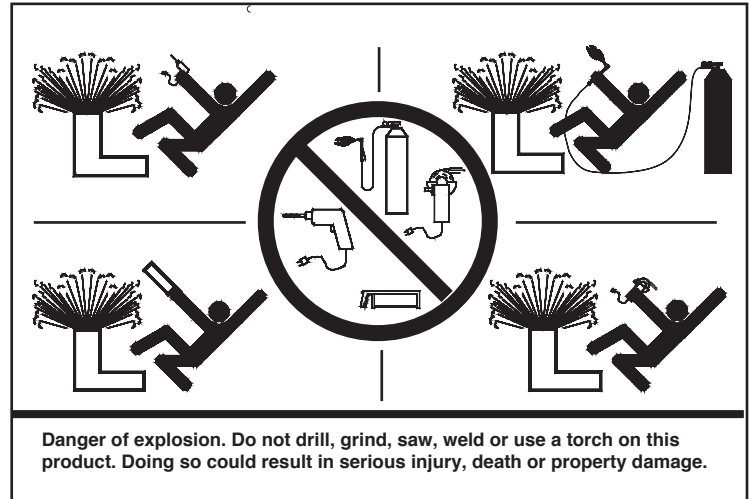

**Note:** A filter **must** be used when transferring fluid from the tank when using a pump.

This transfer tank does not comply with the following specifications:

- Title 49 of the Code of Federal Regulations for the interstate transfer of flammables, explosives, hazardous materials and hazardous wastes.
- Underwriters' Laboratories of Canada C142.13 requirements for transportation of flammables and combustible liquids.

These tanks may also be subject to individual state or province regulations, compliance with which is the responsibility of the owner.

**Note:** Use pipe tape when using a manual or electric transfer pump on the tank.

Transfer tank and pump must be grounded to prevent static charge build-up.

**Future Tank Removal:** Empty all of the combustible liquid and use all lifting hooks for safe and controlled removal of transfer tank from the vehicle.







## TOOLS REQUIRED

- Electric Drill
- Bits: 3/16" & 9/16"
- Pipe Wrench
- Open or Box End Wrench - (2) 3/4"
- Pipe Tape

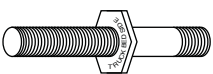

## CONTENTS

					
(1) Transfer Tank	(1) Filler Cap	(1) Bolt Kit			

## BOLT KIT CONTENTS

					
(4) 1/2-13 x 4-1/2 Mounting Stud	(8) 1/2-13 Nylock Nut	(8) 1/2" Fender Washer	(1) 1/4" Drain Plug	(4) Floor Mounting Spacer	(4) Urethane/Rubber Bushing

## ALUMINUM BED UPFIT KIT PARTS LIST - 32-0245 (kit within tank bolt kit)

					
(1) Zinc Rich Primer	(4) 9/16" x 1-1/2" Plastic Washer				

# INSTALLATION INSTRUCTIONS

**Note:** If your truck bed is constructed of aluminum, use zinc rich primer to coat drilled holes.

## STEP 1 Installing the Transfer Tank

Place tank in desired location in bed of pick-up.  
Be sure tank is not rubbing edges of the cargo bed.

**Note:** · When installing model 352 Transfer Tank with a 27" tool box in a full size short bed pickup, the Tank will need to be mounted with filler openings toward center of the bed to avoid tool box hitting wheel wells. Check the fitment of the tank with any product being installed along with it. It may be necessary to place the column of the L tank toward the rear of the bed.

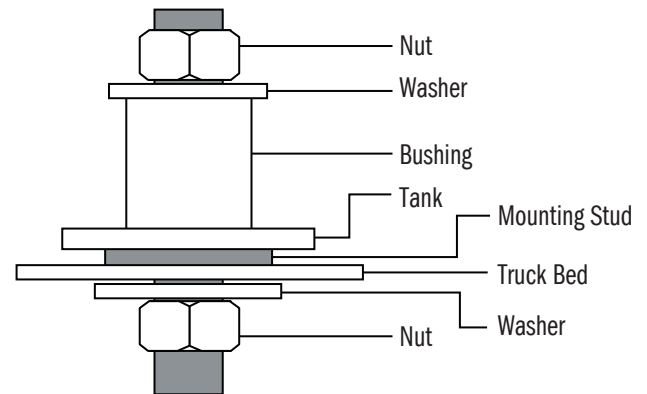
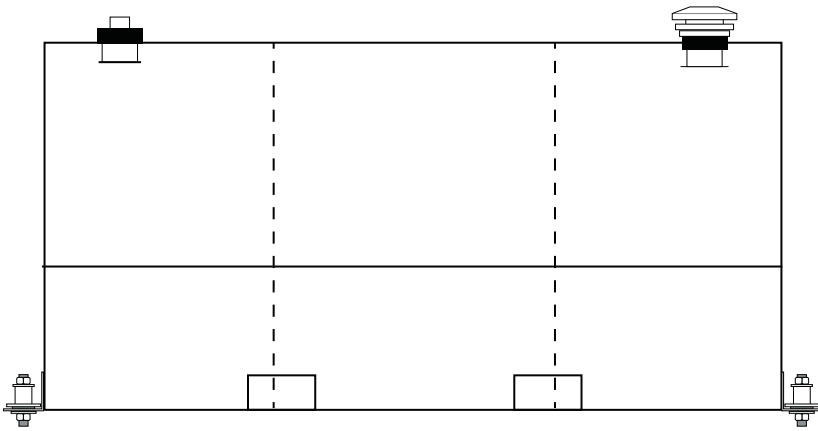

## STEP 2 Mark and Drill the Holes

**Note:** · If any drilled holes fall between the ribs on the lower part of the floor, it will be necessary to use floor spacers between the tank mounting angle and the floor.  
· Make sure the drain plug is accessible when installing.

With the tank in place, use a visible marker to mark the location of the drill holes. (Remove the tank before drilling the mounting holes).

Drill 9/16" holes in marked location

### ⚠ CAUTION

Check to ensure the area is free of fuel lines, brake lines, and wiring.

## STEP 3 Secure the Tank

From the top, insert Mounting Studs into 9/16" holes in the truck bed with "TRUCK BED SIDE" markings down.  
Secure Mounting Studs by attaching Fender Washer & Nylock Nut onto bottom of each Mounting Stud underneath truck bed.  
Slip tank mounting feet over secured Mounting Studs.  
On top of tank mounting feet, attach Bushing, Fender Washer & Nylock Nut onto Mounting Stud  
Do not overtighten Nylock Nut! Compress Bushing 1/8" to 1/4" only.

### ALUMINUM TRUCK BED INSTALLATION:

Use one 7/16 x 1-1/2" plastic washer as a barrier between the heavy flat washer and the truck bed.

- Before installing filler cap neck, wrap threaded end with pipe tape. Do not use liquid or paste plumber's pipe dope. Install the filler cap neck, using a pipe wrench to tighten. Install vented fuel cap.
- The filler cap provided with this tank is designed to relieve pressure at 2 to 3.5 psi, and vacuum releases at 2 oz. Transfer pumps with a flow rate greater than 25 GPM will exceed the cap's ability to vent.

# INSTALLATION INSTRUCTIONS - MODEL 359-X-02

If your truck bed is constructed of aluminum, use zinc rich primer to coat drilled holes.







## TOOLS REQUIRED

- Electric Drill
- Bits: 3/16", 1/2", & 9/16"
- Pipe Wrench
- Open or Box End Wrench - (1) 9/16", (1) 1/2", & (2) 3/4"
- Pipe Tape

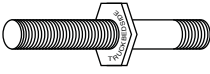
## CONTENTS

					
(1) Transfer Tank	(1) Filler Cap	(1) Bolt Kit			

## BOLT KIT CONTENTS

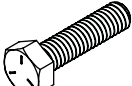
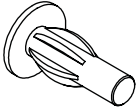
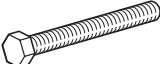
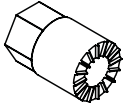
					
(2) 1/2-13 x 4-1/2 Mounting Stud	(4) 1/2-13 Nylock Nut	(4) 1/2" Fender Washer	(1) 1/4" Drain Plug	(4) Floor Mounting Spacer	(2) Urethane/ Rubber Bushing
					
(2) 5/16-18 x 1" Bolt	(2) 5/16-18 Blind Fastener	(2) 5/16-18 x 2 1/4" Bolt	Blind Fastener Tool		

## ALUMINUM BED UPFIT KIT PARTS LIST - 32-0245 (kit within tank bolt kit)

					
(1) Zinc Rich Primer	(4) 9/16" x 1-1/2" Plastic Washer				

### STEP 1 Installing the Transfer Tank

Place tank in desired location in bed of pick-up.

Be sure tank is not rubbing edges of the cargo bed.

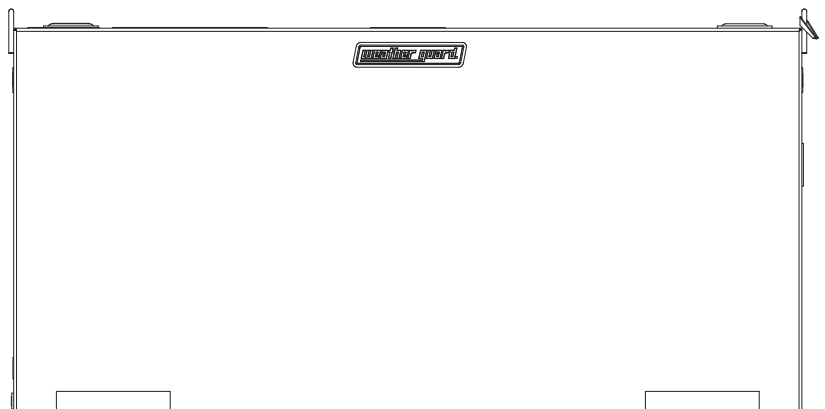

# INSTALLATION INSTRUCTIONS - MODEL 359-X-02

If your truck bed is constructed of aluminum, use zinc rich primer to coat drilled holes.

## STEP 2 Mark and Drill the Holes

- Note:**
- If any drilled holes fall between the ribs on the lower part of the floor, it will be necessary to use floor spacers between the tank mounting angle and the floor.
  - Make sure the drain plug is accessible when installing.

Place the tank in the position desire for install and use a visible marker to mark the location of the drill holes. (Remove the tank before drilling the mounting holes).

Drill 9/16" holes in marked location.

### CAUTION

Check to ensure the area is free of fuel lines, brake lines, and wiring.

## STEP 3 Secure the Mounting Studs

- Note:**
- Use pipe tape when using a manual or electric transfer pump on the tank. Transfer tank and pump must be grounded to prevent static charge build-up.

From the top, insert Mounting Studs into 9/16" holes in the truck bed with "TRUCK BED SIDE" markings down.

Secure Mounting Studs by attaching Fender Washer & Nylock Nut onto bottom of each Mounting Stud underneath truck bed.

Slip tank mounting feet over secured Mounting Studs.

On top of tank mounting feet, attach Bushing, Fender Washer & Nylock Nut onto Mounting Stud

Do not overtighten Nylock Nut! Compress Bushing 1/8" to 1/4" only.

### ALUMINUM TRUCK BED INSTALLATION:

Use one 7/16 x 1-1/2" plastic washer as a barrier between the heavy flat washer and the truck bed.

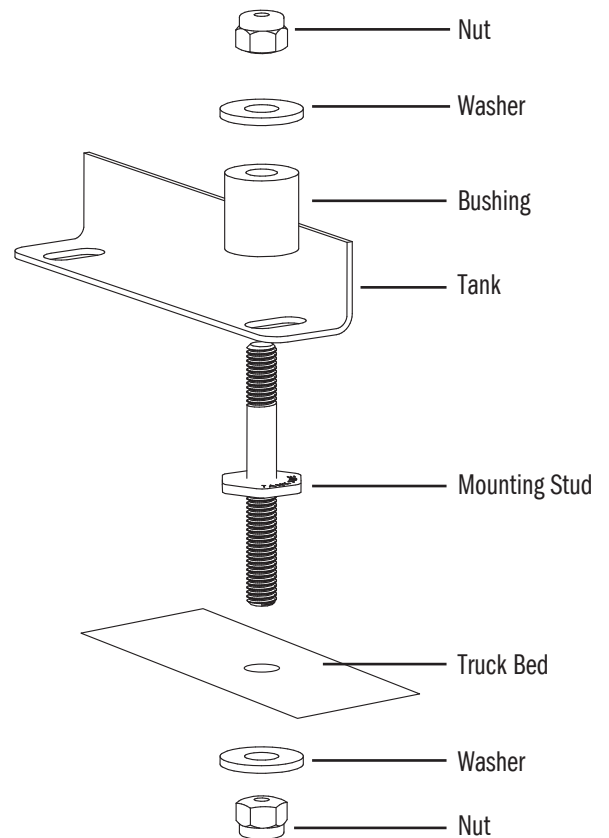
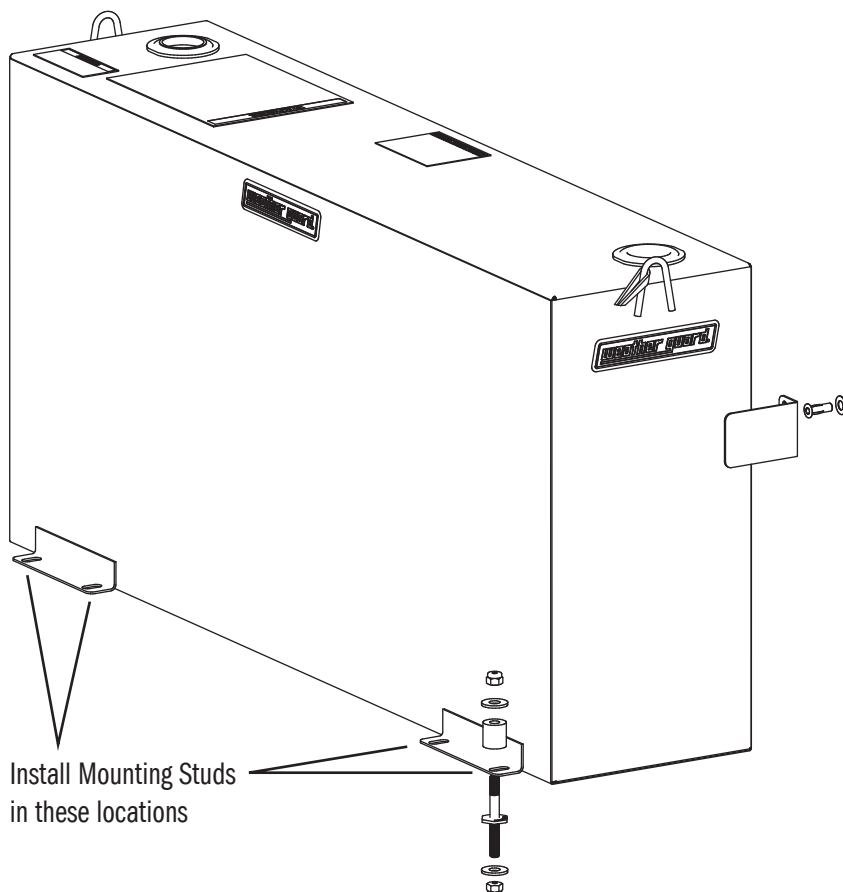

# INSTALLATION INSTRUCTIONS - MODEL 359-X-02

If your truck bed is constructed of aluminum, use zinc rich primer to coat drilled holes.

## STEP 4 Secure the Blind Fasteners

Before installing blind fasteners, verify the location of wiring, air-bags, sense wires, etc. so you don't accidentally damage something important.

Slip a washer on the 5/16-18 x 2 1/4 in. bolt, and pass them through the 9/16 wrench and installation tool as show at right. Place a drop of oil on the 5/16-18 bolt before threading on the blind fastener.

Place the blind fastener through the hole and use the 1/2 in. wrench or socket to tighten the bolt until the blind fastener is fully seated.

As the blind fastener "bulbs-out" it will get easier to turn until it bottoms out and "sets". Make sure that the blind fastener and installation tool do not turn during installation.

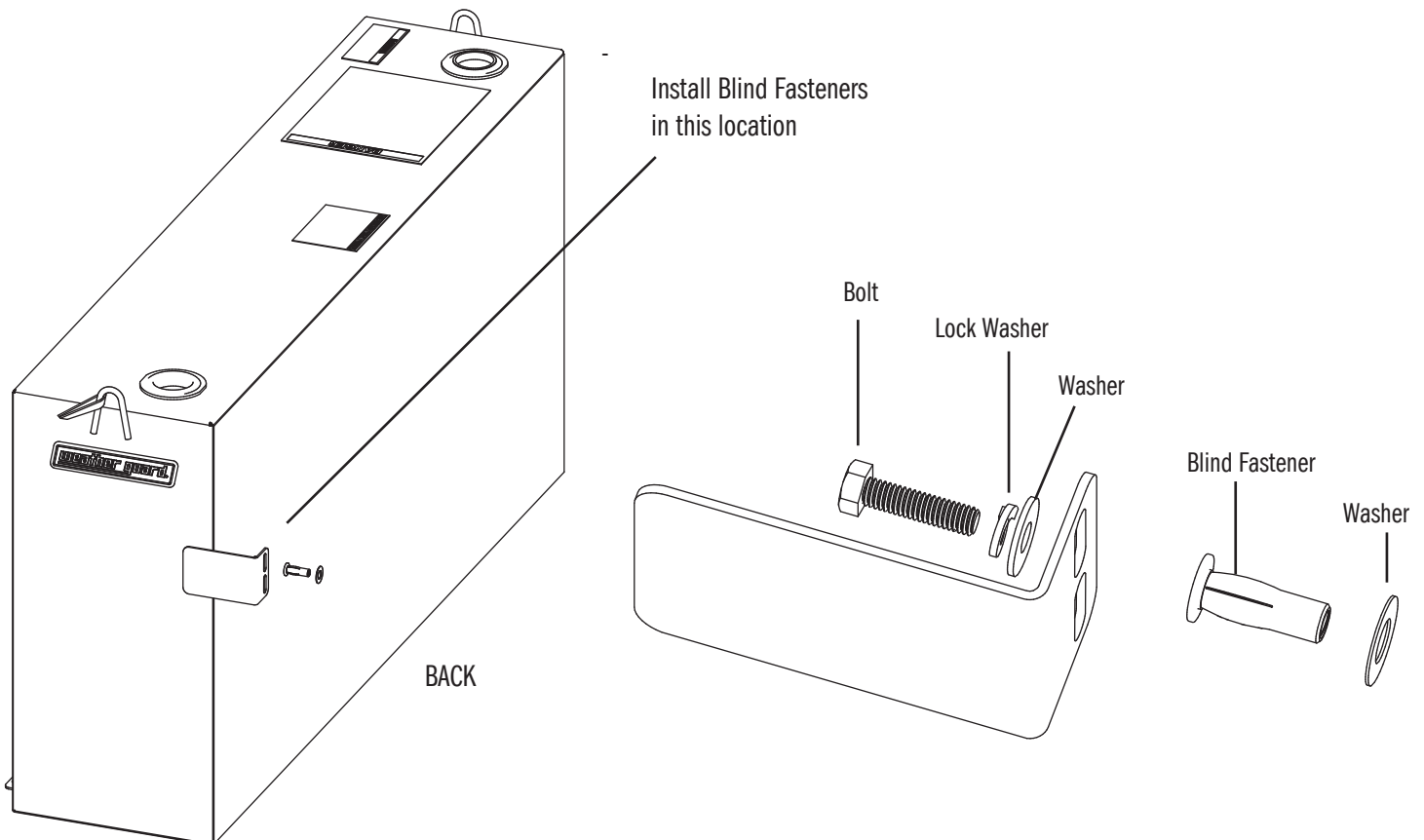
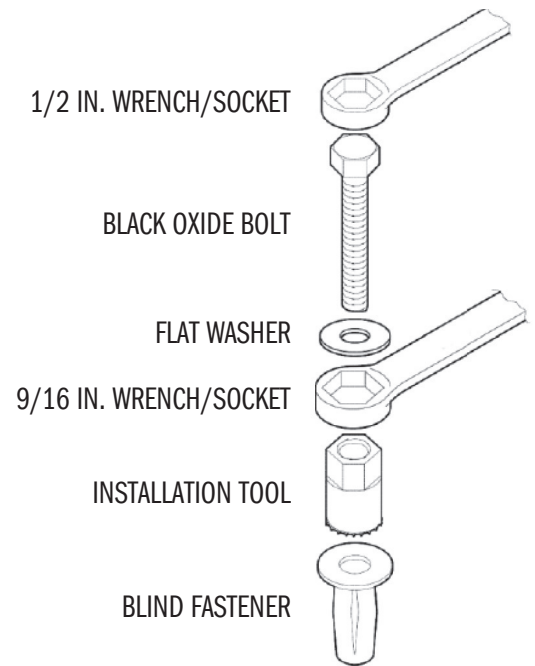

# WERNER CO. LIMITED LIFETIME WARRANTY FOR WEATHER GUARD® PRODUCTS

## WEATHER GUARD® Products – Limited Lifetime Warranty (Purchased on or after 1/1/2009)

WERNER CO. (the “Manufacturer”) warrants to the original purchaser only that WEATHER GUARD® Truck and Van Products (the “WEATHER GUARD® Product”) will be free from defects in material and workmanship from the date of purchase and continuing for the expected lifetime of the WEATHER GUARD® Product. A copy of the original sales receipt must be supplied to the Manufacturer at the time a warranty claim is made. This warranty terminates if the original purchaser transfers the WEATHER GUARD® Product to any other person.

### What is Covered

All WEATHER GUARD® Products identified above that are purchased on or after January 1, 2009.

### What We Will Do To Correct Problems

Subject to the limitations and exclusions described in this limited warranty, the Manufacturer will remedy defects in materials or workmanship by providing one of the following remedies at its option and without charge to the original purchaser for parts or labor: (a) repairing the defective portion of the WEATHER GUARD® Product or (b) replacing the entire WEATHER GUARD® Product. In addition, the Manufacturer may elect at its option, not to repair or replace the WEATHER GUARD® Product, but rather issue to the original purchaser a refund equal to the purchase price paid for the WEATHER GUARD® Product or a credit to be used toward the purchase of a new WEATHER GUARD® Product.

### What is Not Covered

This limited warranty expressly excludes:

- Defects caused by normal wear and tear, cosmetic rust, scratches, accidents, unlawful vehicle operation, or modification to the product, or any types or repair of a WEATHER GUARD® Product other than those authorized or provided by the Manufacturer.
- Defects resulting from conditions beyond the Manufacturer’s control including, but not limited to misuse, overloading, or failure to assemble, mount or use the WEATHER GUARD® Product in accordance with the Manufacturer’s written instructions or guidelines included with the WEATHER GUARD® Product or made available to the original purchaser.
- Damage to the contents of the box or vehicle.
- TO THE EXTENT PERMITTED BY LAW, IN NO EVENT SHALL THE MANUFACTURER BE LIABLE FOR ANY INCIDENTAL, SPECIAL, INDIRECT, OR CONSEQUENTIAL DAMAGES, INCLUDING ANY ECONOMIC LOSS, WHETHER RESULTING FROM NONPERFORMANCE, USE, MISUSE OR INABILITY TO USE THE WEATHER GUARD® PRODUCT OR THE MANUFACTURER’S NEGLIGENCE.

### No Other Express Warranty Applies

This Limited Lifetime Warranty is the sole and exclusive warranty for WEATHER GUARD® Products. No employee, agent, dealer, or other person is authorized to alter this warranty or make any other warranty on behalf of WERNER CO.

### Notification Procedures

If the WEATHER GUARD® Product does not conform with the terms of this limited warranty, the original owner must promptly notify the Manufacturer in writing upon discovery of the nonconformity. In order to receive the remedies under this limited warranty, the warranty claim must describe the nature of the nonconformity, and a copy of the original sales receipt, invoice, bill or other proof of purchase must accompany the claim. Repairs or modifications made to the WEATHER GUARD® Product by other than the Manufacturer or its authorized agent will nullify this limited warranty. Coverage under this limited warranty is conditioned at all times upon the owner’s compliance with these required notification and repair procedures. Warranty claims must include reciprocal contact information and may be made via certified mail to:

WERNER CO.  
ATTN: Warranty Claims  
420 E. Terra Cotta Avenue  
Crystal Lake, IL 60014



If you have any questions,  
please call toll free at 1-800-456-7865

**WERNERCO™**